



S E R V E R

SERVE BETTER™

MODEL:

SY 1.5

**SYRUP SERVER,
1.5 GALLON**

120V

Series 03G

85480

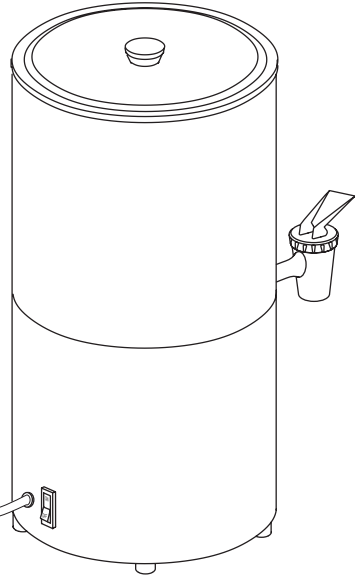
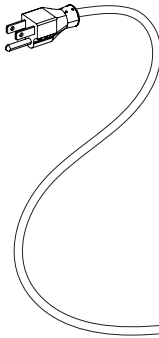

SY

**SYRUP SERVER,
3 GALLON**

120V

Series 04B

84190

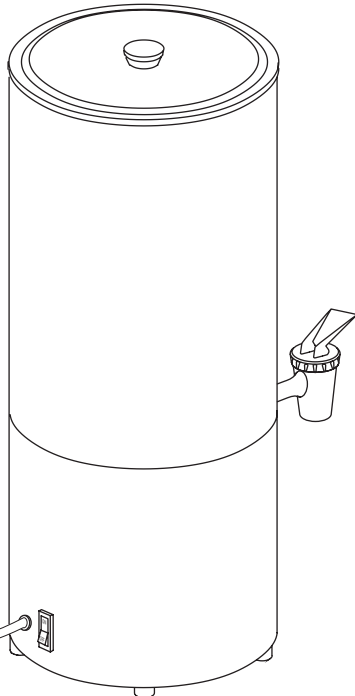
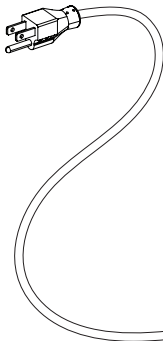

SAFETY GUIDELINES WHEN USING THIS UNIT:



Warning- Electrical shock could occur:

- This unit must be earthed or grounded.
- This requires all three prongs (terminals) on cord plug to be plugged into power source.

According to food and safety regulations, most foods must be stored and/or served at certain temperatures or they could become hazardous. Check with local food and safety regulators for specific guidelines.

Be aware of the product you are serving and the temperature the product is required to maintain. Server Products, Inc. can not be responsible for the serving of potentially hazardous product.

Stainless steel is one of the best materials for food serving and storage, but there are many products which can corrode it. If you notice corrosion beginning on any stainless steel surface, you may need to change the cleansing agent, sanitizing agent, or the cleaning procedures you are using.

- Products containing: acids, alkalines, chlorine, or salt can corrode stainless steel.
- Sauerkraut and Au Jus sauces corrode stainless steel. Server Products, Inc. regrets that we can not honor Warranty claims on stainless steel parts that have been affected by sauerkraut or Au Jus.

SAFETY GUIDELINES WHEN CLEANING THIS UNIT:

Ensure unit is "OFF" and unplugged.



Caution- Hot:

- If unit has already been in use, unit may still be hot. Allow unit to cool before continuing.



Warning- Electrical shock could occur:

- Electrical components of unit could be damaged from water exposure or any liquid.
- Never immerse unit into water or any liquid.
- Never use any water jet or pressure sprayer on unit.

UNIT TAKE-DOWN

- 1 PRESS SWITCH TO "OFF" POSITION.
- 2 UNPLUG CORD.



Caution- Hot:

- If unit has already been in use, unit may still be hot. Allow unit to cool before continuing.

- 3 REMOVE COVER FROM UNIT.
- 4 EMPTY PRODUCT OUT OF VESSEL BY POURING CONTENTS OUT OVER A DRAIN OR INTO A STORAGE CONTAINER.
- 5 REMOVE FAUCET FROM UNIT BY UNSCREWING FROM BASE OF UNIT.
- 6 DISASSEMBLE FAUCET BY UNSCREWING BONNET FROM TOP OF BODY. THEN REMOVE CUP SEAT FROM STEM.

IMPORTANT: FAUCET MUST BE FULLY DISASSEMBLED AND CLEANED DAILY TO PREVENT DRIPPING.

UNIT SET-UP

ALWAYS CLEAN UNIT AND FAUCET THOROUGHLY BEFORE EACH USE. SEE UNIT TAKE-DOWN, SAFETY GUIDELINES AND CLEANING.

- 1 MAKE SURE FAUCET IS CORRECTLY ASSEMBLED AND SECURED ONTO BASE PRIOR TO FILLING VESSEL WITH PRODUCT.

Thermostat Lock is preset at 140°F (60°C), but is adjustable up to 180°F (82°C):

- 2 IF NECESSARY, ADJUST THERMOSTAT LOCK TO RECOMMENDED PRODUCT SERVING TEMPERATURE.
 - Prior to filling vessel with product, or when vessel is empty, set unit upside down on a work surface.
 - Remove screw on thermostat lock by unscrewing it counterclockwise.
 - Set thermostat lock to desired temperature. Thermostat lock rotates like a dial.
 - Secure thermostat lock with screw. Rotate screw clockwise to tighten.
- 3 FILL VESSEL WITH PRODUCT TO BE SERVED.
- 4 INSTALL COVER ONTO UNIT.
- 5 PLUG CORD INTO POWER SOURCE.
- 6 PRESS SWITCH TO THE "ON" POSITION.

Server Products Inc. claims no responsibility for actual serving temperature of product. It is the responsibility of the user to ensure that any product is held and served at a safe temperature.

FAUCET ASSEMBLY 85487

- 1 INSTALL CUP SEAT INTO FAUCET STEM.
- 2 INSTALL BONNET ONTO TOP OF FAUCET BODY.
- 3 SECURE BONNET TO FAUCET BODY BY ROTATING BONNET CLOCKWISE. IF BONNET IS WET, IT WILL ASSEMBLE MUCH EASIER.
- 4 INSTALL CONICAL SHAPED RUBBER WASHER ONTO THREADED SHANK OF FAUCET.
- 5 INSTALL FAUCET INTO HOLE.
- 6 INSTALL NUT ONTO FAUCET THREADED SHANK. BE CAREFUL NOT TO CROSS THREAD.
- 7 SECURE NUT, WASHER, AND FAUCET TIGHTLY TOGETHER BY ROTATING NUT CLOCKWISE.

IMPORTANT:

- Conical shaped rubber washer must be positioned with larger side facing faucet.
- Do not over tighten nut. Overtightening nut will strip faucet threads and cause washer to leak.
- Overtightening nut will squeeze conical shaped washer flat against server vessel and will cause it to leak.
- Conical shaped rubber washer seals on inside of hole.
- It is a flexible seal, therefore it is possible to move or rotate faucet and not create a leak.
- Do not attempt to rotate faucet and flatten conical shaped rubber washer with intent to tighten seal.

FAUCET ASSEMBLY

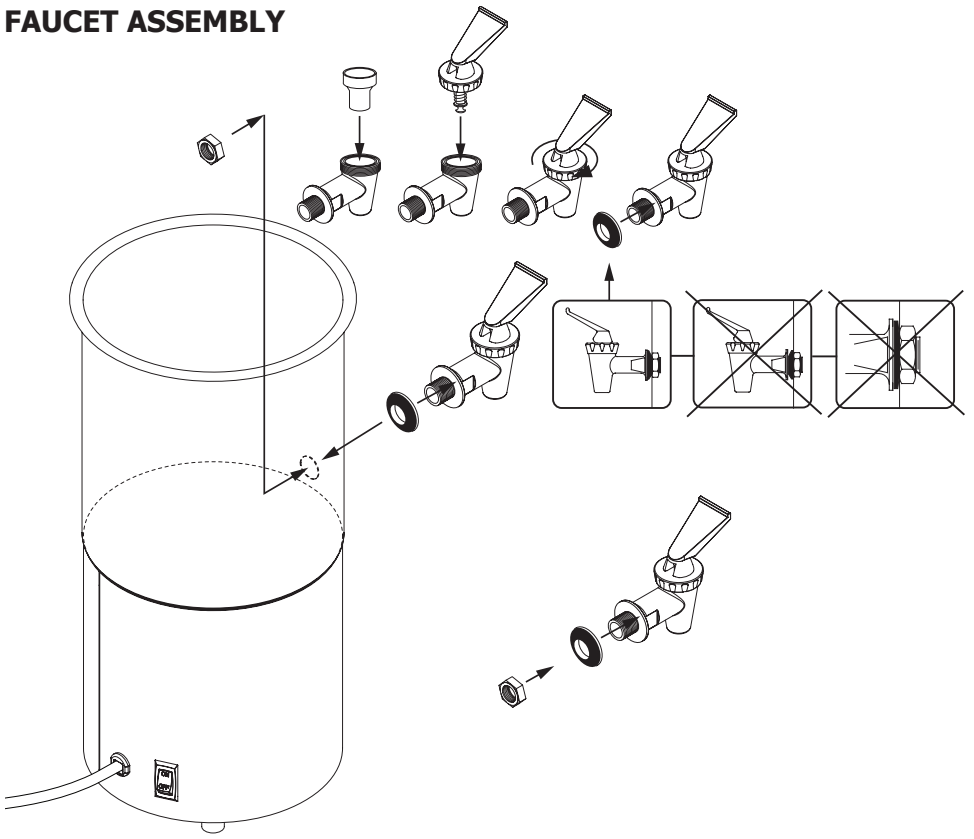

UNIT SET-UP

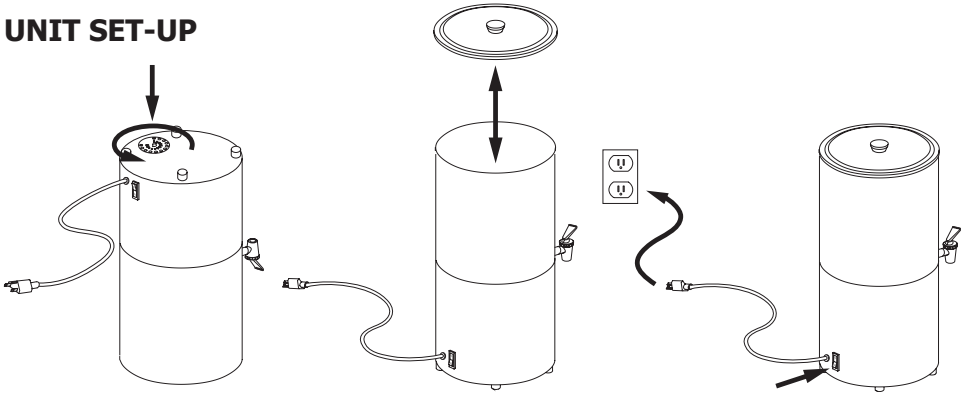

UNIT TAKE-DOWN

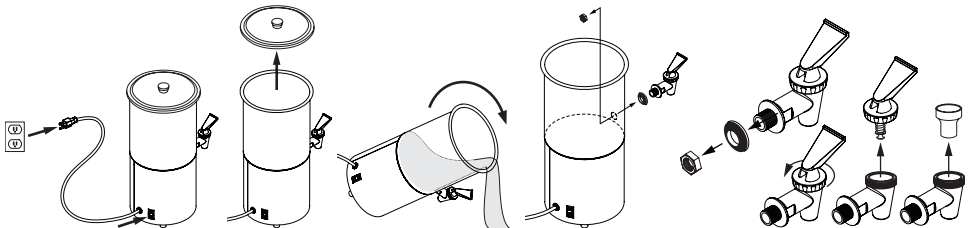

UNIT CLEANING

BEFORE FIRST USE AND AFTER USE DAILY OR REGULARLY, DISASSEMBLE AND CLEAN PARTS. FOR SAFE AND PROPER CARE, AND TO PREVENT CORROSION, OF PARTS, IT IS IMPORTANT TO CLEAN, RINSE, SANITIZE, AND DRY PARTS DAILY OR REGULARLY. FAILURE TO COMPLY WITH ANY OF THESE INSTRUCTIONS MAY VOID UNIT WARRANTY.

- 1 SEE UNIT TAKE DOWN.
- 2 ENSURE UNIT IS "OFF" AND UNPLUGGED.



Warning- Electrical shock could occur:

- **Electrical components of unit could be damaged from water exposure or any liquid.**
 - **Never immerse unit into water or any liquid.**
 - **Never use any water jet or pressure sprayer on unit.**
- 3 WASH CLEAN ALL WASHABLE PARTS WITH DISHWASHING DETERGENT AND HOT WATER.
 - Do not use scrapers, steel pads, steel wool, or other cleaning tools that can scratch surfaces.
 - Mildly abrasive NYLON or brass brush may be used to remove any stubborn food or mineral deposits on interior surfaces of unit.
 - Do not use abrasive cleansers.
 - Do not use caustic cleansers.
 - Do not use cleansing agents with high concentrations of acid, alkaline or chlorine.
 - Do not use ammonia based cleansers.
 - 4 FULLY RINSE ALL WASHED PARTS THOROUGHLY WITH CLEAR WATER.
 - To prevent corrosion on parts, it is important to thoroughly and fully rinse washed parts.
 - 5 WIPE CLEAN EXTERNAL SURFACES OF UNIT WITH A CLEAN DAMP CLOTH.
 - Nontoxic glass cleaner may be used to clean stainless steel parts.
 - 6 DRY ALL PARTS WITH A CLEAN SOFT CLOTH.
 - Various elements and minerals, such as chlorides in tap water, can accumulate on stainless steel parts and create corrosion.
 - To prevent corrosion on stainless steel parts, it is important to thoroughly and fully dry with a clean soft cloth regularly.
 - 7 SANITIZE ALL PARTS FOLLOWING LOCAL SANITIZATION REQUIREMENTS. ALL PARTS IN CONTACT WITH FOOD MUST BE SANITIZED.
 - Allow parts to fully air dry after sanitization.

UNIT TROUBLESHOOTING

Possible Problem:

- Unit does not heat.

Possible Solutions:

- Ensure cord is securely plugged in.
- Ensure power is available from source.
- Ensure unit is on.
- Ensure thermostat lock is set correctly.

GENERAL SERVICE, REPAIR, OR RETURNS

Before sending any item to Server Products for service, repair, or return, contact Server Products customer service to request a **Return Authorization Number**. Merchandise must be sent to Server Products with this number.

Merchandise being returned for credit must be in new and unused condition and not more than 90 days old and will be subject to a 20% (percent) restocking charge. Electrical parts (thermostats, heating elements, etc.) are not returnable.

Server Products maintains a fully staffed service department with highly skilled factory trained personnel. Service is extremely prompt. Under normal circumstances, a repaired unit is shipped out the day after it is received. Labor charges are reasonable.

SERVICE

Contact your dealer or Server Products Inc. customer service department for the following:

ORDERING REPLACEMENT PARTS

Be prepared to give this information:

- Model Letters/Name/Numbers
- Part Numbers- P/N
- Series Numbers/Letters
- Part Description

This information and other important data is stamped on the lid or cylinder of pumps or on the bottom or back side of every unit.

Servicing Cord

Specific tools are required for safe and proper power supply cord removal and installation. If cord must be replaced, only a representative of the OEM (original equipment manufacturer) or a qualified technician may replace cord. Cord must meet code designation H05 RN-F requirements.

SERVER PRODUCTS LIMITED WARRANTY

All Server Products equipment is backed by a two-year limited warranty against defects in materials and workmanship. For complete warranty information go to: www.server-products.com



Server Products Inc.

3601 Pleasant Hill Road
Richfield, WI 53076 USA



262.628.5600



800.558.8722



262.628.5110



spsales@server-products.com



www.server-products.com